

# wing

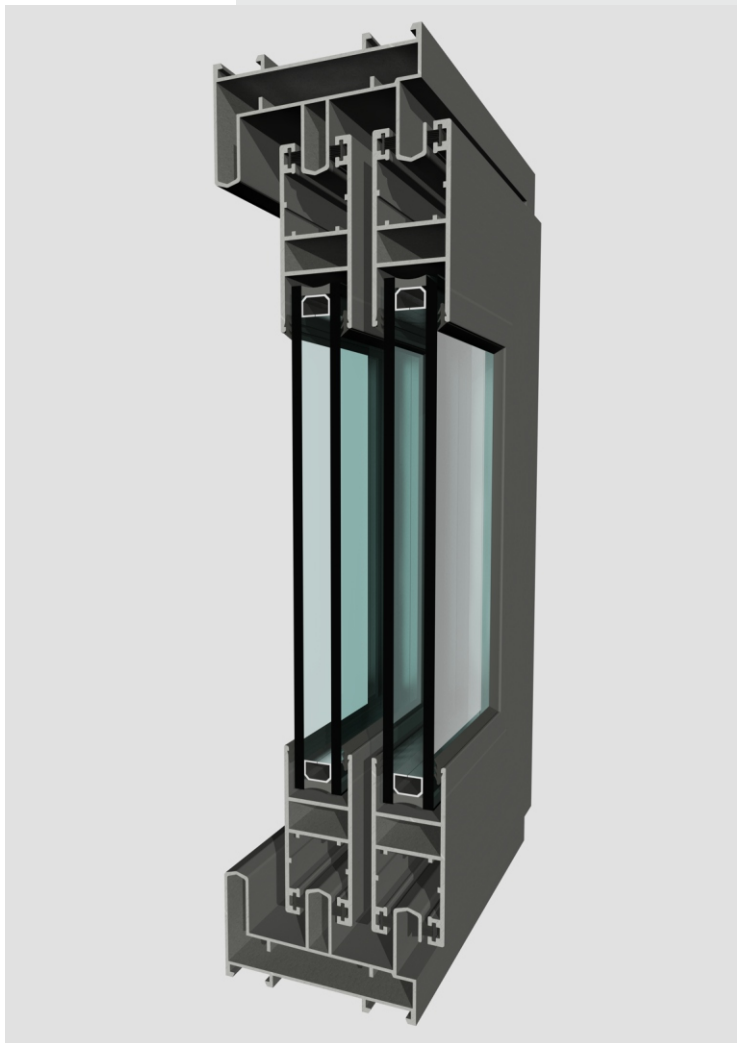

April 2012.god



Sistem WING je sistem bez termičkog prekida namijenjen za izradu kliznih vrata i prozora, izuzetnih mehaničkih osobina uz odličan funkcionalni i estetski dizajn.

Osnovne dimenzije profila iz sistema:

|              |              |
|--------------|--------------|
| širina štoka | širina krila |
| 47 mm        | 28 mm        |

Za ovaj sistem predviđeno je ostakljenje od 21mm.

Zaptivanje između krila i štoka se ostvaruje pomoću četkica koje se postavljaju na krilu.

Za ovaj sistem postoje posebni okovi.

Spajanje profila se vrši montažno-demontažnim spojnica.

Legura: AlMgSi0,5 (DIN1725) (EN AW 6060).

Hemijski sastav legure:

| legura    | legirajući elementi % |      |      |      |      |      |      |       | spec. težina<br>kg/dm <sup>3</sup> |      |
|-----------|-----------------------|------|------|------|------|------|------|-------|------------------------------------|------|
|           | Cu                    | Mn   | Mg   | Si   | Fe   | Zn   | Cr   | Ti+Cr |                                    |      |
| AlMgSi0,5 | min.                  |      |      | 0,30 | 0,30 | 0,10 |      |       |                                    | 2,70 |
|           | max.                  | 0,10 | 0,10 | 0,60 | 0,50 | 0,30 | 0,15 | 0,05  | 0,10                               | 2,75 |

Mehaničke osobine profila i tolerancije oblika i mjera u skladu sa DIN17615 - tvrdoća 70 HB.

Plastifikacija: debljina sloja 80 μm, u skladu sa standardom RAL-RG 631.

Anodizacija: debljina sloja 20μm, u skladu sa standardom DIN17611

Standardna dužina profila: 6 i 6,5 m.

ISO 9001:2000  
ISO 14001:2004

#### SADRŽAJ KATALOGA

|                  |    |
|------------------|----|
| profili 1:4      | 3  |
| profili 1:1      | 5  |
| pribori          | 9  |
| presjeci         | 13 |
| analiza sječenja | 23 |

Profiles in WING system are without thermal brake. WING is appropriated for sliding doors and windows with excellent mechanical properties with excellent functional and estetic design.

Basic dimension of profiles from system:

|                  |               |
|------------------|---------------|
| widht of channel | widht of sash |
| 47 mm            | 28 mm         |

WING system use glazing from 21mm.

Sealing between channel and sash with brushes which are insulated in sash.

System has special accessories.

For WING system we have screw corners.

Alloy: AlMgSi0,5 (DIN1725) (EN AW 6060).

Chemical property of alloy:

| alloy     | alloying elements % |      |      |      |      |      |      |       | density<br>kg/dm <sup>3</sup> |      |
|-----------|---------------------|------|------|------|------|------|------|-------|-------------------------------|------|
|           | Cu                  | Mn   | Mg   | Si   | Fe   | Zn   | Cr   | Ti+Cr |                               |      |
| AlMgSi0,5 | min.                |      |      | 0,30 | 0,30 | 0,10 |      |       |                               | 2,70 |
|           | max.                | 0,10 | 0,10 | 0,60 | 0,50 | 0,30 | 0,15 | 0,05  | 0,10                          | 2,75 |

Mechanical properties of profiles and tolerancies of shape and dimensions according to DIN17615 - hardness 70 HB.

Powder coating: thicknes of coating 80 μm, according to RAL-RG 631.

Anodizing: thicknes of coating 20μm, according to DIN17611

Lenght of bars: 6 i 6,5 m.

ISO 9001:2000  
ISO 14001:2004





#### CONTENT OF CATALOGUE

|                  |    |
|------------------|----|
| profiles 1:4     | 3  |
| profiles 1:1     | 5  |
| accessories      | 9  |
| sections         | 13 |
| cutting analysis | 23 |

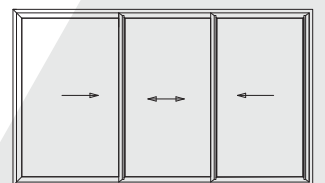
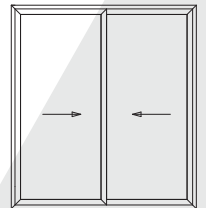
wing

pregled profila 1:4/profiles overview 1:4

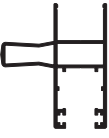

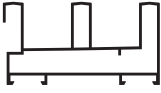
|  |   |  |
|--|---|--|
| 45023<br>profil za zatvaranje<br>hook            |  | X mm: 30.5<br>Y mm: 37<br>težina/weight<br>0.297 kg/m<br>moment inercije/<br>moment of inertia   |
| 45024<br>dodatni profil<br>adjoining profile     |  | X mm: 19.5<br>Y mm: 22.4<br>težina/weight<br>0.178 kg/m<br>moment inercije/<br>moment of inertia |
| 45030<br>"H" prečka<br>"H" profile               |  | X mm: 28<br>Y mm: 66<br>težina/weight<br>0.845 kg/m<br>moment inercije/<br>moment of inertia     |
| 45022<br>krilo sa rukohvatom<br>sash with handle |    | X mm: 56<br>Y mm: 66<br>težina/weight<br>1.144 kg/m<br>moment inercije/<br>moment of inertia     |
| 45021<br>krilo<br>sash                           |    | X mm: 28<br>Y mm: 66<br>težina/weight<br>0.882 kg/m<br>moment inercije/<br>moment of inertia     |
| 45012<br>dvostruka vodica<br>double channel      |    | X mm: 47<br>Y mm: 46.8<br>težina/weight<br>1.048 kg/m<br>moment inercije/<br>moment of inertia   |
| 45013<br>trostruka vodica<br>triple channel      |    | X mm: 83<br>Y mm: 44<br>težina/weight<br>1.439 kg/m<br>moment inercije/<br>moment of inertia     |

profila 1:1/profiles 1:1

WING

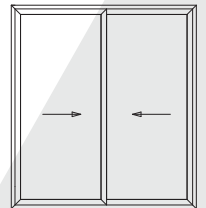

trostruka vodica/triple channel

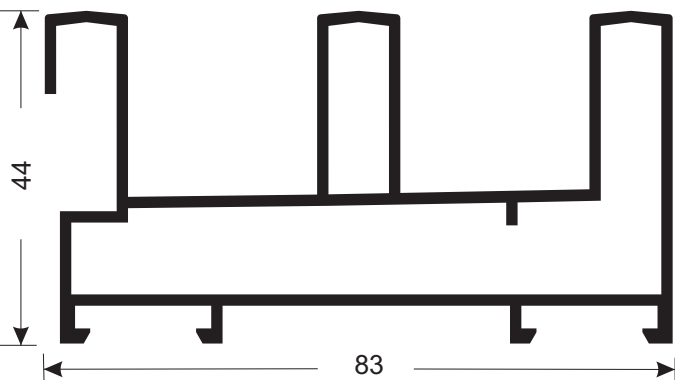

1,439 kg/m

45013

dvostruka vodica/double channel

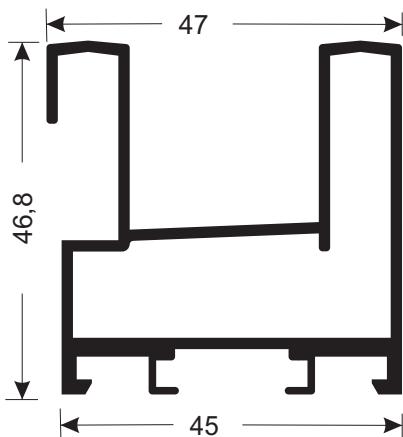

1,048 kg/m

45012

krilo sa rukohvatom/sash with handle

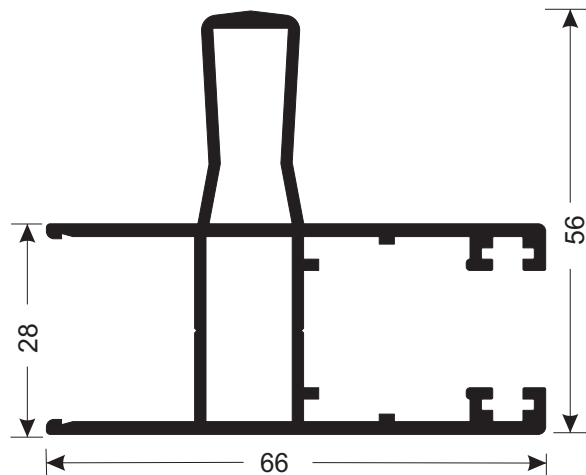

1,144 kg/m

45022

krilo/sash

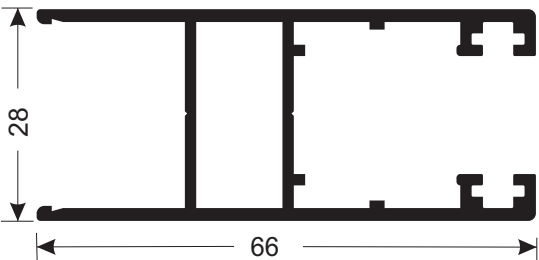

0,882 kg/m

45021

profil za zaptivanje krilo-krilo/adjoining profile

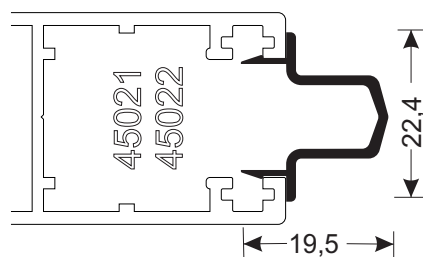

0,178 kg/m

45024



"H" prečka/"H" profile

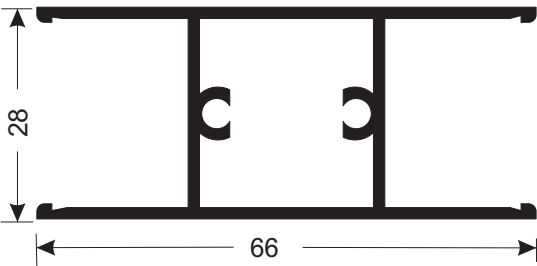

0,845 kg/m

45030

profil za zatvaranje/hook

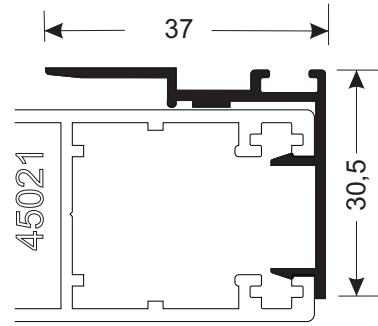

0,297 kg/m

45023

wing

pribori/accessories

WING

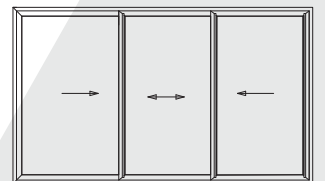
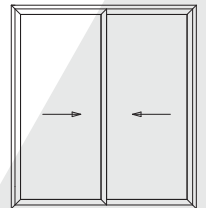

zatvaranje bez zaključavanja/closing without locking

3087



upotreba/use for: \_\_\_\_\_

materijal/material: \_\_\_\_\_

poklopac za odvod vode/water cap

IN 023



upotreba/use for: \_\_\_\_\_

materijal/material:  
PVC  
crna/black, bijela/white

zavtarač/locker

Gs3000



upotreba/use for: \_\_\_\_\_

materijal/material: \_\_\_\_\_

m/d spojnica/screw corner

1401123000



upotreba/use for:  
profili/profiles: 45021,  
45022  
materijal/material:  
aluminijum/aluminium

odbojnik/buffer

560G006



upotreba/use for: \_\_\_\_\_

materijal/material: \_\_\_\_\_

m/d spojnica/screw corner

0432



upotreba/use for:  
profili/profiles: 45012,  
45013  
materijal/material:  
aluminijum/aluminium

čep sa četkicom/cap with brush

560GI01



upotreba/use for: \_\_\_\_\_

materijal/material: \_\_\_\_\_

brava/locker

3352



upotreba/use for: \_\_\_\_\_

materijal/material: \_\_\_\_\_

točkici/wheels

K-190



upotreba/use for: \_\_\_\_\_

materijal/material: \_\_\_\_\_

gumena zaptivka/gasket

918



upotreba/use for: \_\_\_\_\_

materijal/material:  
EPDM  
crna/black

tuljak za odvod vode/cap for water draining

560HI01



upotreba/use for: \_\_\_\_\_

materijal/material:  
PVC  
crna/black

usadna brava/locker

2983



upotreba/use for: \_\_\_\_\_

materijal/material: \_\_\_\_\_

čep za 45022/cap for 45022

560GI03



upotreba/use for:  
profil/profile: 45022

materijal/material:  
PVC  
crna/black

ručica/handle

3172



upotreba/use for: \_\_\_\_\_

materijal/material:  
crna/black

četkica 6,9x5,5/brush 6,9x5,5



upotreba/use for: \_\_\_\_\_

materijal/material: \_\_\_\_\_

brava bez zaključavanja/locker without key



upotreba/use for: \_\_\_\_\_

materijal/material: \_\_\_\_\_

301

brava sa zaključavanjem/locker with key



upotreba/use for: \_\_\_\_\_

materijal/material: \_\_\_\_\_

302

mehanička presa/manual punch machine

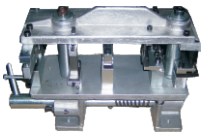

upotreba/use for:  
wing, S100

materijal/material: \_\_\_\_\_

BS 2500

wing

presjeci 1:1/sections 1:1

WING

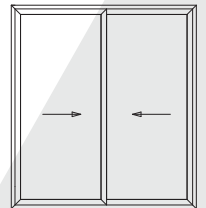

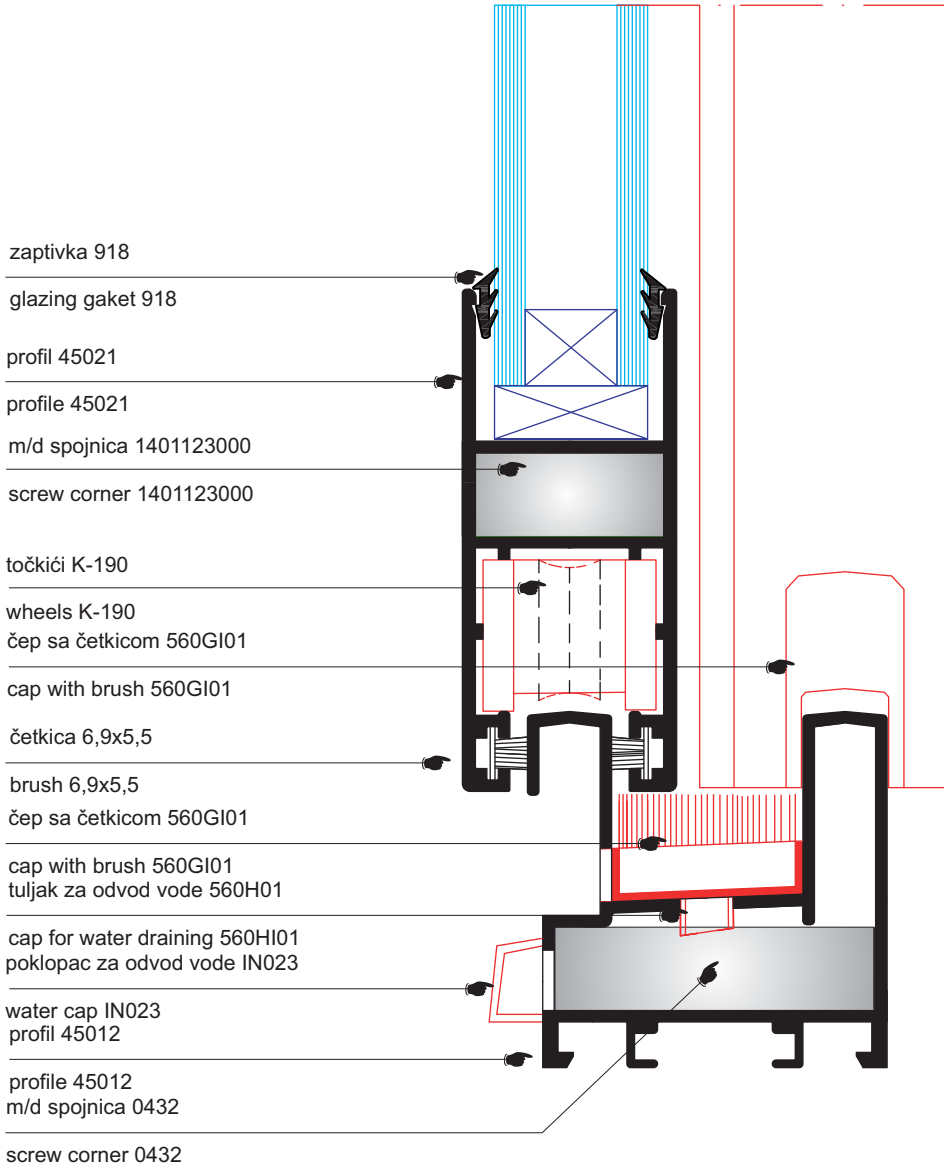



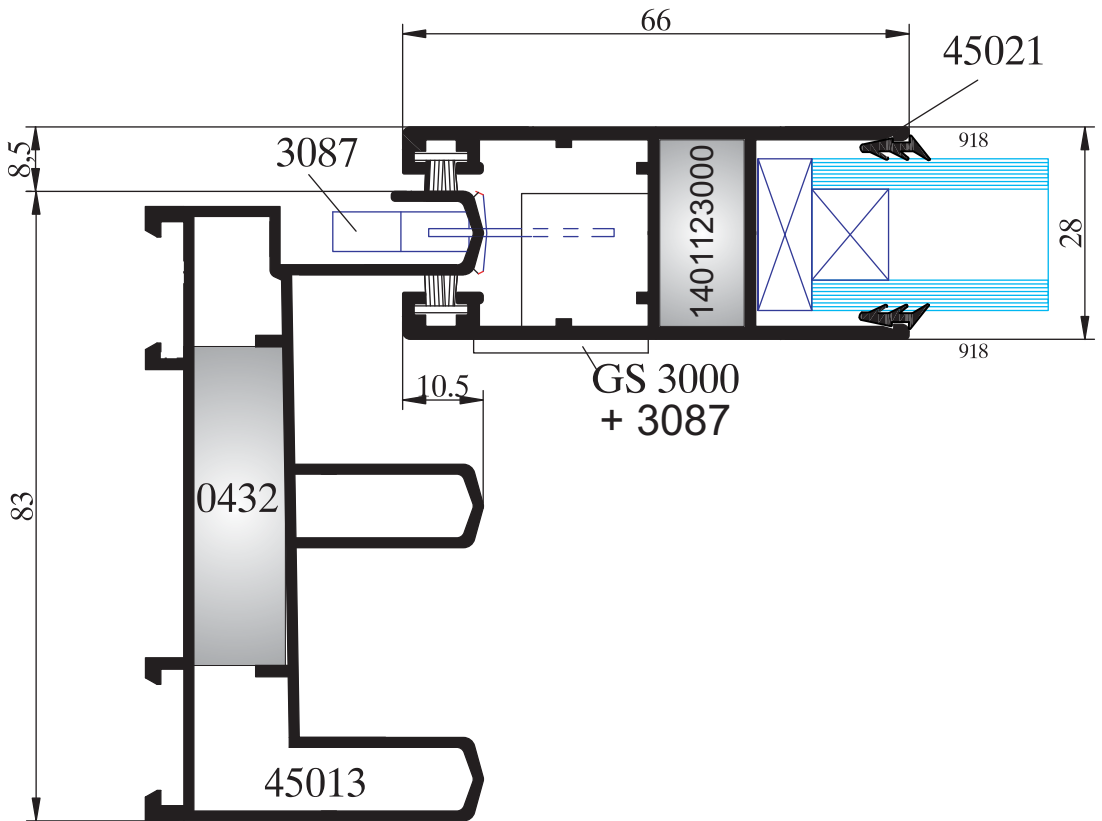
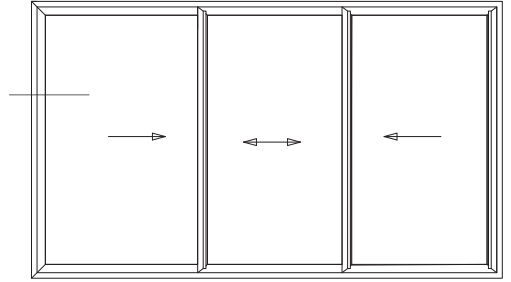

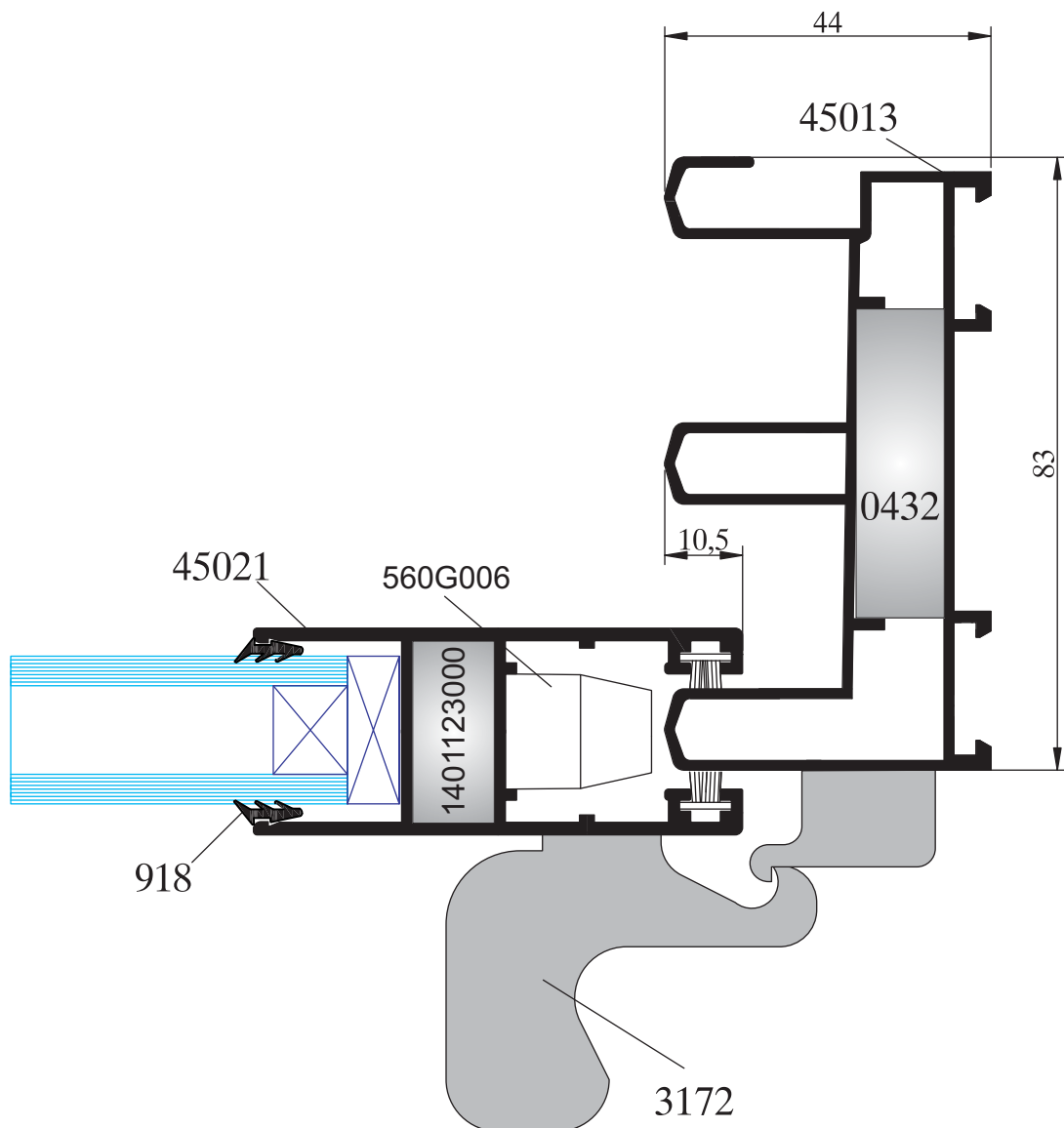
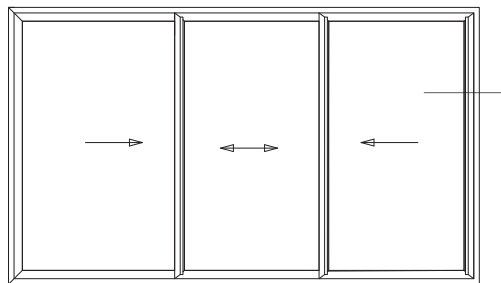

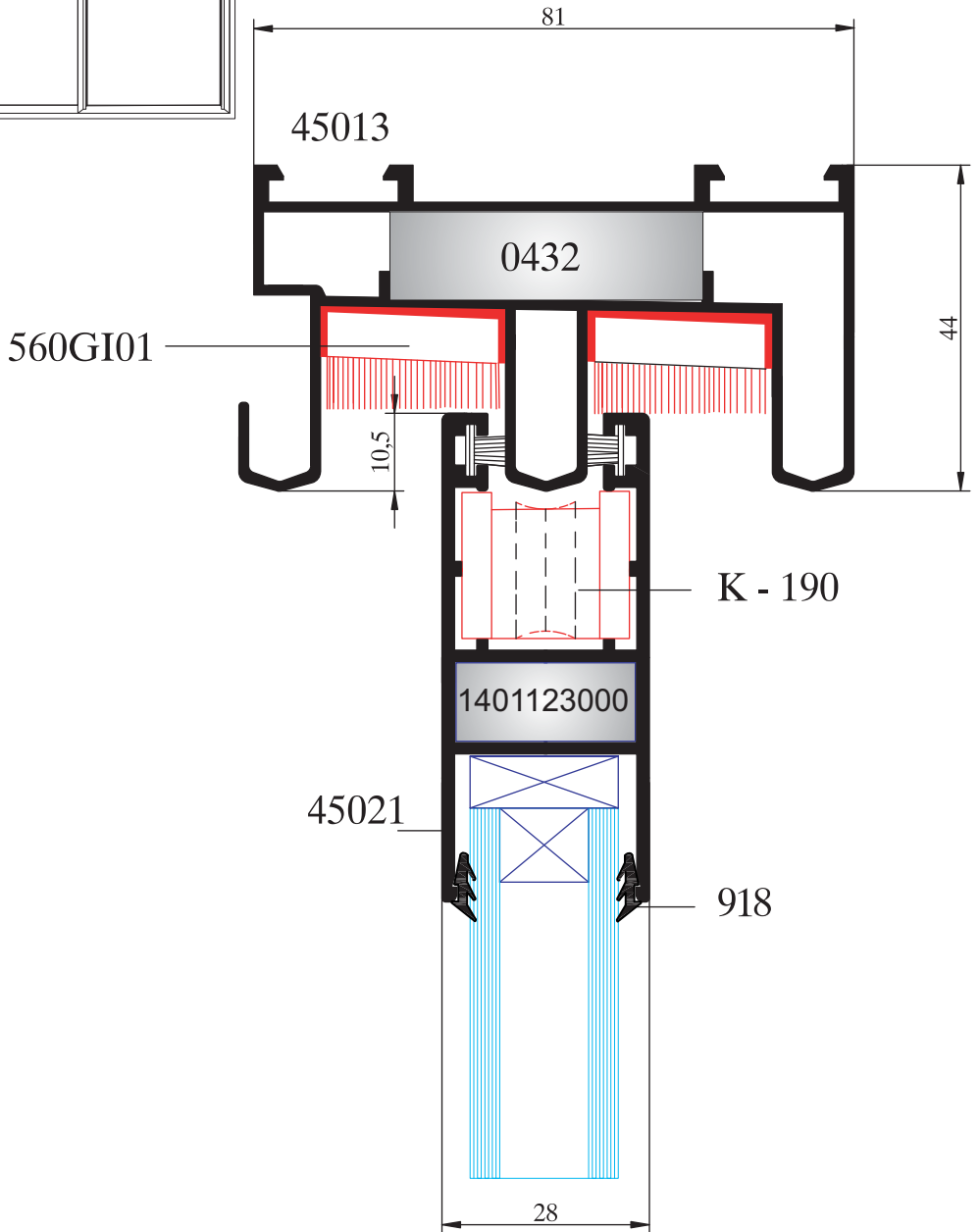
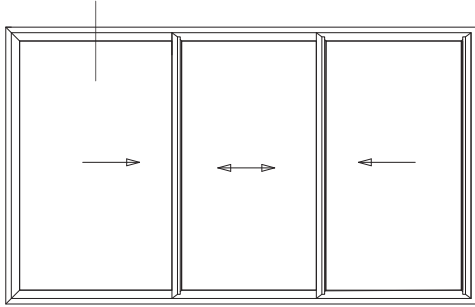

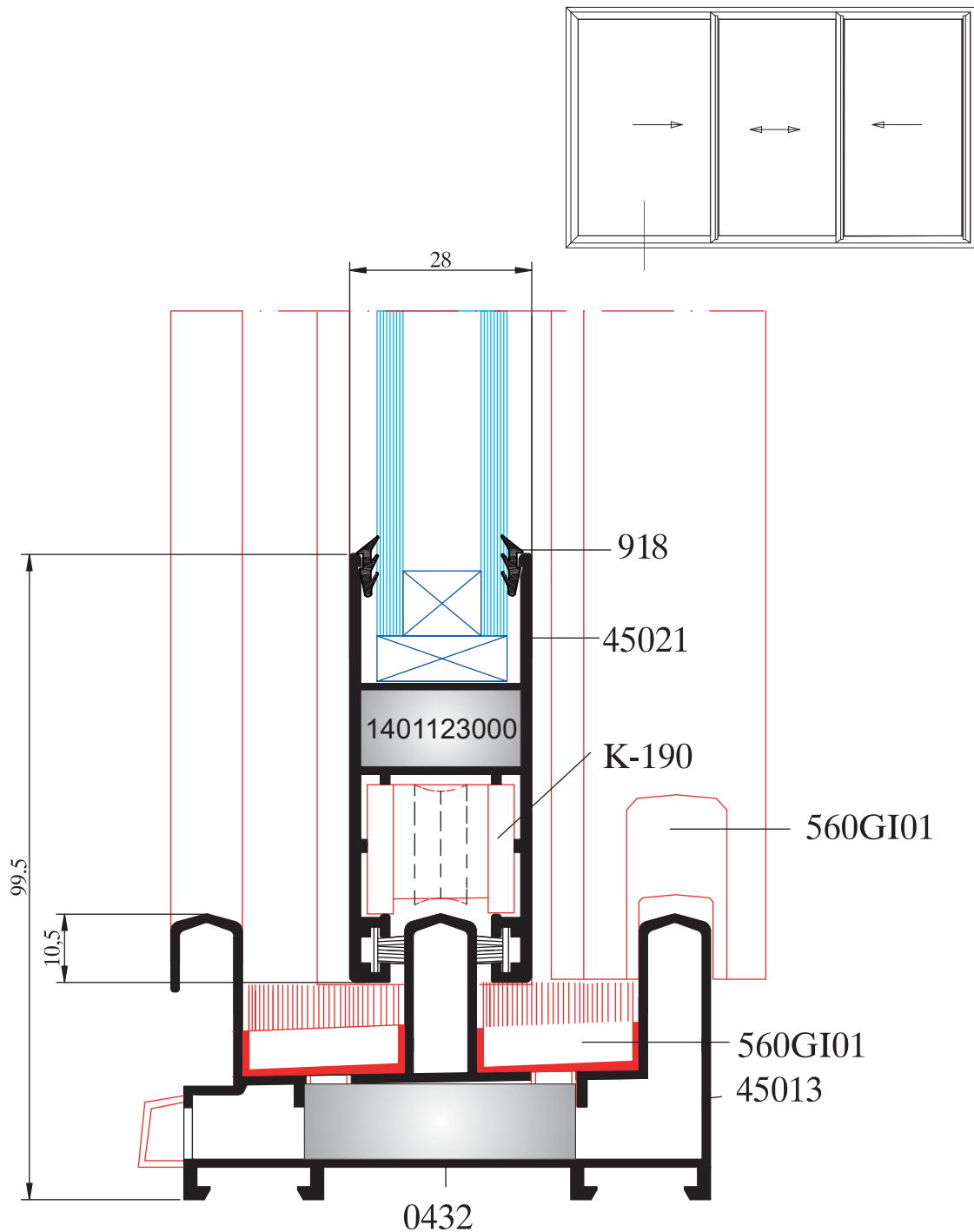

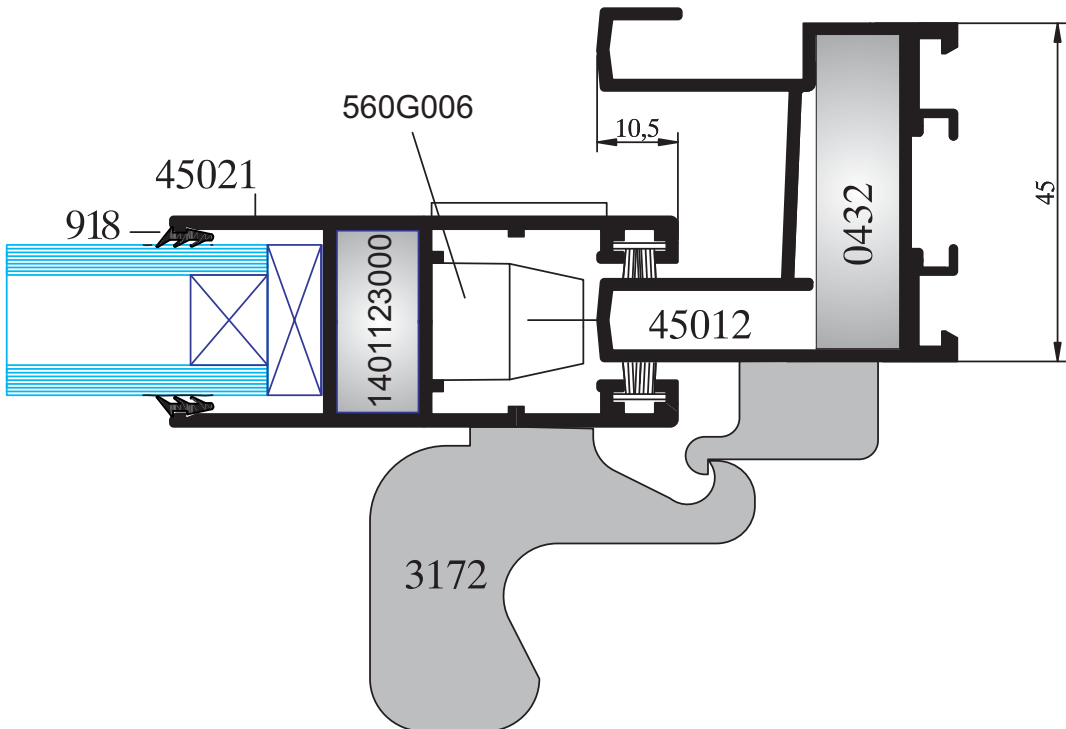
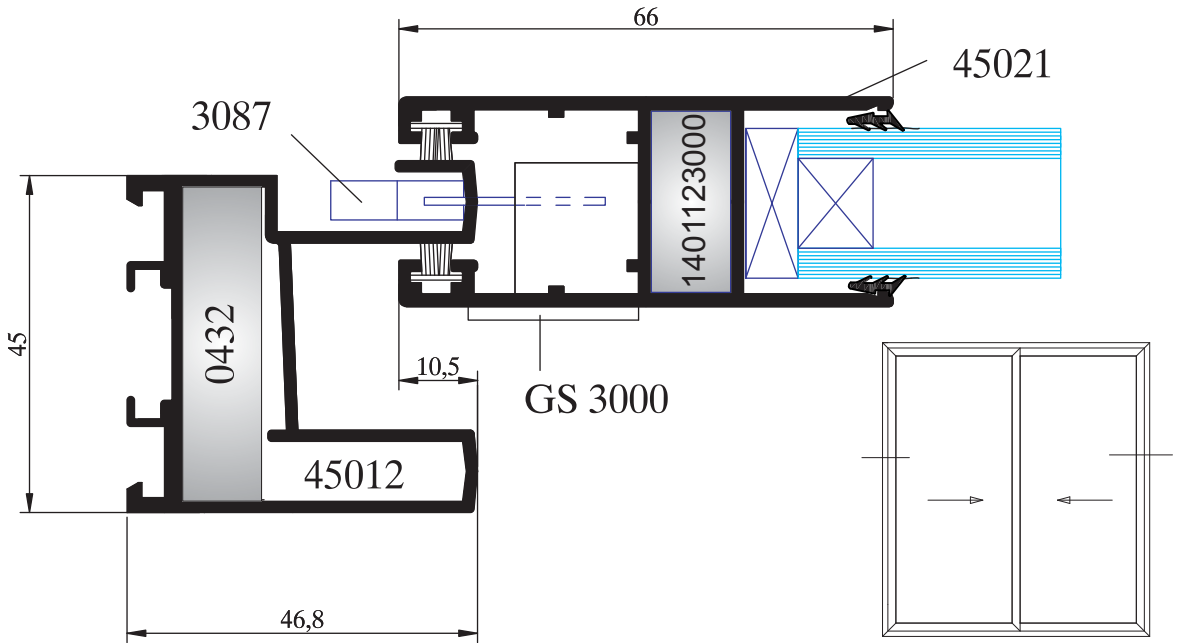

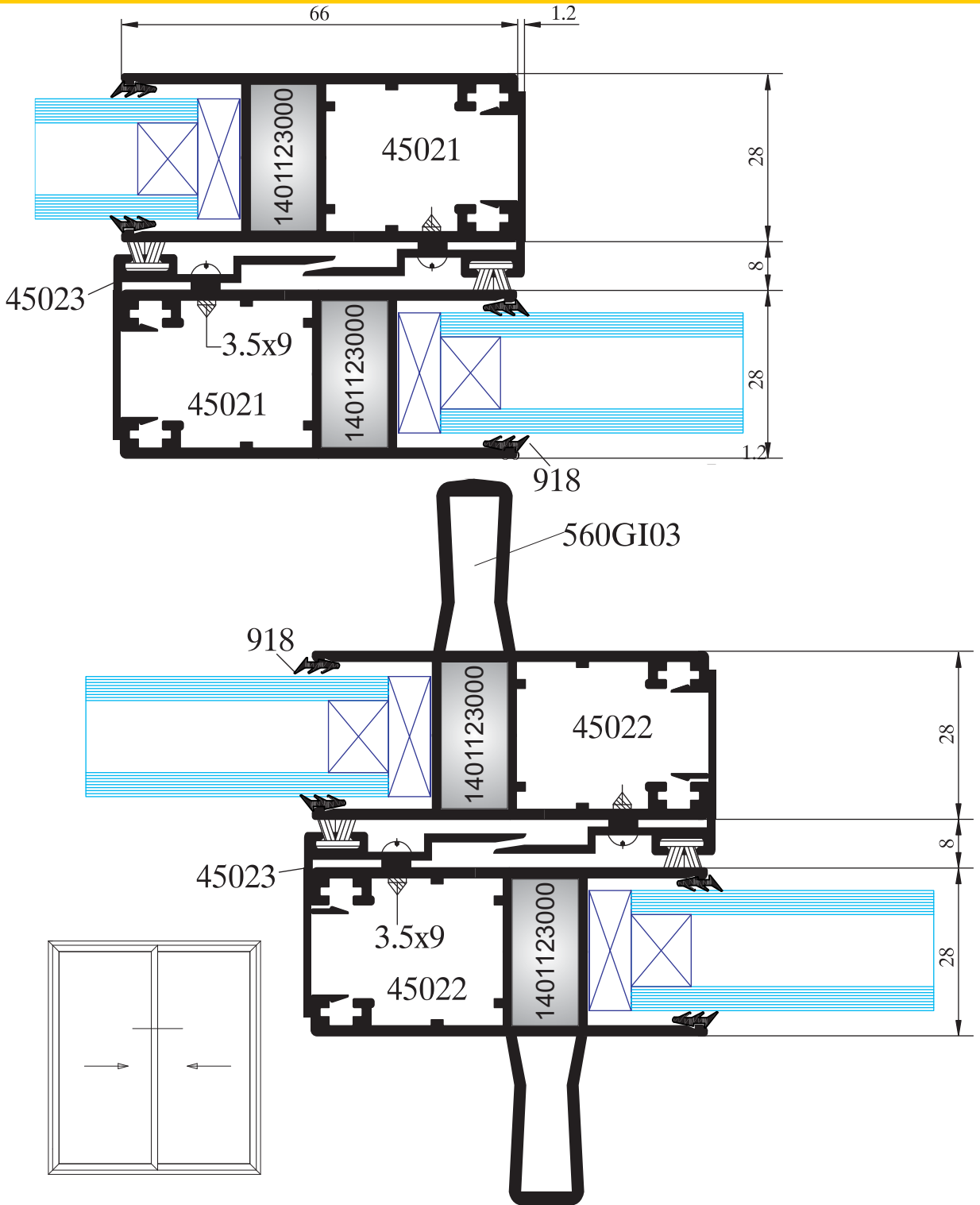

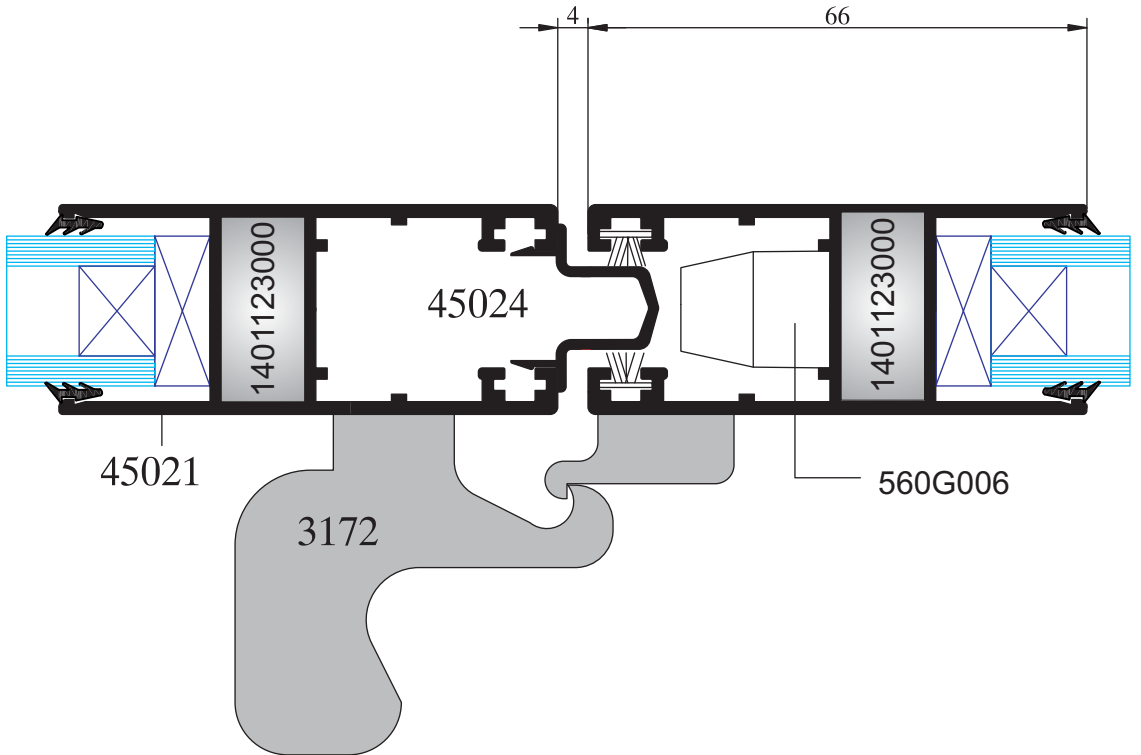
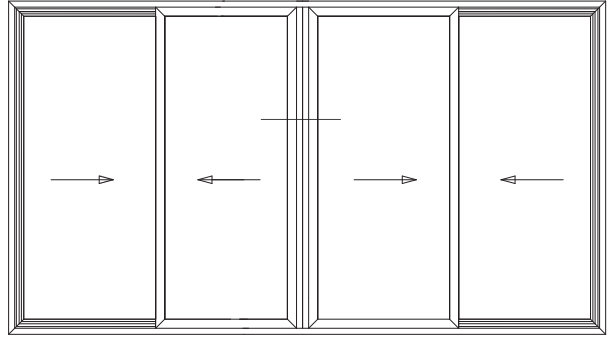

wing



# analiza sječenja/cutting analysis

WING

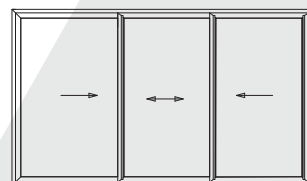
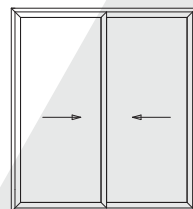

## DVOKRILNI PROZOR-VRATA/DUOBLE LEAF WINDOW-DOOR

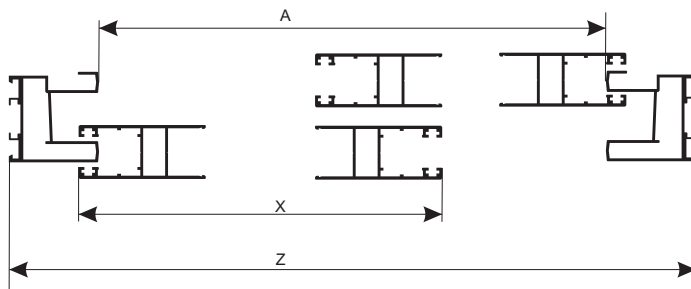
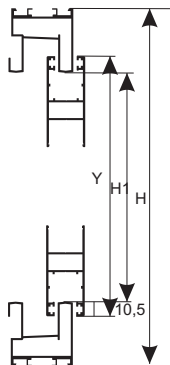

visina krila/  
height of sash

$$Y = H - 72,6\text{mm}$$

ili/or

$$Y = H1 + 21\text{mm}$$

širina krila/  
width of sash

$$X = Z/2 - 3,3\text{mm}$$

ili/or

$$X = A/2 + 43,5\text{mm}$$

## DVOKRILNI PROZOR-VRATA/DUOBLE LEAF WINDOW-DOOR

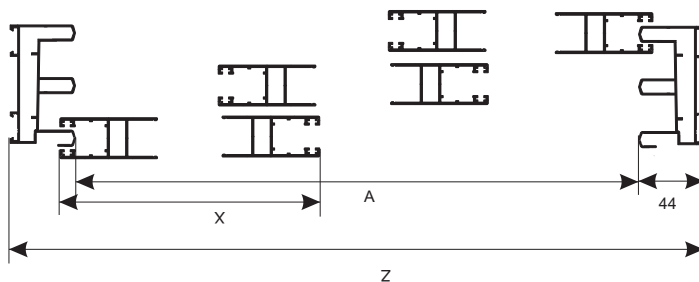
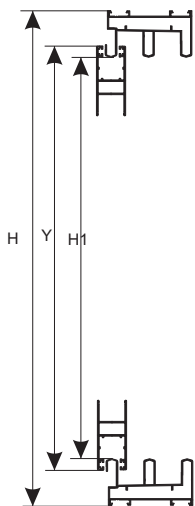

visina krila/  
height of sash

$$Y = H - 67\text{mm}$$

ili/or

$$Y = H1 + 21\text{mm}$$

širina krila/  
width of sash

$$X = Z/3 + 21,73\text{mm}$$

ili/or

$$X = A/2 + 51\text{mm}$$



wing





- Telefoni: ++387 56 733 750; 710 571; 710-690
- Fax: ++387 56 733 196; 710 681
- E-mail: [bhaluminium@alpro-vl.com](mailto:bhaluminium@alpro-vl.com)
- Web: [www.alumil.com](http://www.alumil.com), [www.alumil.ba](http://www.alumil.ba), [www.alpro-vl.com](http://www.alpro-vl.com)